

RM125/RM125R

125W HF-SSB Rack-Mount/Desktop

Continuous Duty Transceivers

Owner's Guide

Table of Contents

| | |
|--|----|
| Introduction..... | 2 |
| Description..... | 2 |
| General..... | 2 |
| Equipment Versions | 3 |
| Main Features | 3 |
| Major Accessories | 4 |
| Performance Specifications..... | 5 |
| Main Technical Characteristics | 5 |
| Accessories Connectors | 7 |
| Ordering Options..... | 8 |
| Familiarization with Equipment..... | 9 |
| Front Panels | 9 |
| RM125/RM125R Rear Panels..... | 10 |
| RM125/RM125R Installation | 12 |
| Installation Planning Guidelines..... | 12 |
| Preparations for Installation | 14 |
| Installation Procedure – Basic Radio..... | 14 |
| Installation Procedure – Radio with PPS Option | 16 |
| RM125/RM125R Operation..... | 18 |
| General..... | 18 |
| Preparations for Operation..... | 18 |
| Operating Instructions..... | 18 |
| RM1200 1 kW Power Amplifier Option | 19 |
| 1 kW System Description | 19 |
| Functional Description | 20 |
| RM1200 Main Technical Characteristics..... | 22 |
| Familiarization with RM1200 Equipment..... | 24 |
| RM1200 Equipment Installation | 30 |
| Preparations for Installation | 31 |
| Installation Procedure | 32 |
| RM1200 Operation..... | 34 |

Introduction

This manual covers the installation and operation of the MICOM RM125 and RM125R 125W HF-SSB rack-mount/desktop continuous duty transceivers, part of the MICOM-3 line of HF-SSB radio sets. It also presents the FLN3175 MICOM RM1200 1 kW linear high-power RF amplifier unit, which uses the RM125 or RM125R as exciter for a complete 1 kW transceiver.

The manual covers only procedures specific to the MICOM RM125/RM125R and RM1200; the other procedures, which are common to the whole MICOM-3 product line, are described in the “Owner’s Guide, MICOM-3E/3T/3R HF-SSB Transceivers”, Publication 6886867J01, and in other MICOM-3 Supplements that cover optional features applicable to your radio set.

Description

General

Figure 1 shows a general view of a typical 125W transceiver (the RM125 version).

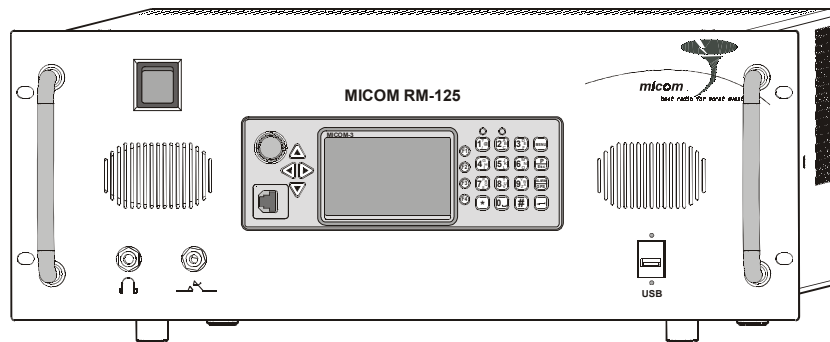

Figure 1. Typical RM125, General View

The RM125/RM125R radio set includes a standard MICOM-3 transceiver, with a 110/220 VAC, 50/60 Hz power supply contained in a compact chassis, suitable for installation in a 19” rack or desktop.

Internal cooling fans enable operation over a wide range of temperatures, for continuous-duty data transmission. The radio has multiple accessories connectors, for system interconnections.

The AC input voltage range is automatically switched between 110 and 220 VAC, and therefore the equipment can be used in the United States of America as well as in other countries. As a backup, RM125/RM125R can also use 13.8 V DC power from an external lead-gel or lead-acid battery, which is automatically charged by the internal AC power supply. When an external battery is connected, the RM125/RM125R can continue operating on battery power during AC mains failure or in case the AC power is switched off.

Note *An external 13.8 VDC DC power source, suitable for powering HF-SSB transceivers, can also be used. The external source must be connected through a series protection diode and a 30A fuse.*

The RM125 and RM125R are well suited for base station applications, and can be directly connected to a wide range of broadband or tuned antennas, including whip, dipole, traveling wave, delta, and

semi-delta antennas. Two main options further enhance the range of applications for the RM125 and RM125R:

- MICOM RM1200 Linear High-Power RF Amplifier, FLN3175. This compact amplifier, which covers the full transmit range of the RM125/RM125R, 1.60 to 30 MHz range, offers significantly higher transmit power (1 kW PEP and average), and thus enable improved communications under bad propagation conditions and/or strong interference.
- Interface for Pre-Selector/Post-Selector (PPS), option G65: the PPS is intended for RM125 and RM125R installed in multiple-transmitter or split sites, as it permits operation of collocated receivers and transmitters on frequencies separated by as little as 10%. The PPS operating frequency range is 1.60 to 29.99 MHz.

Note *The G65 option does not include the Pre-Selector/Post-Selector (PPS) unit, which must be separately ordered.*

Being part of the MICOM-3 line, RM125 and RM125R offer similar capabilities and characteristics and use common operating procedures, thereby enabling personnel familiar with the operation of MICOM-3 equipment to start using the RM125/RM125R with minimal training.

Equipment Versions

MICOM RM125

Transceiver for long range wireless voice, fax, data and email communications.

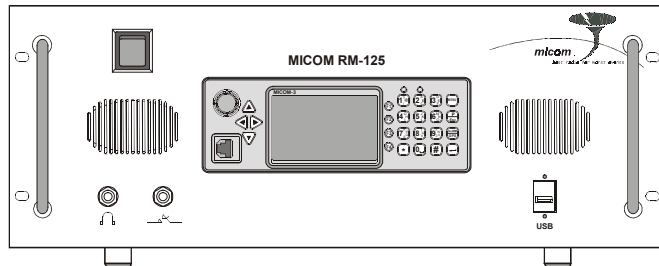

MICOM RM125R

Ruggedized transceiver with military handset and connectors, for applications requiring the utmost dependability and reliability.

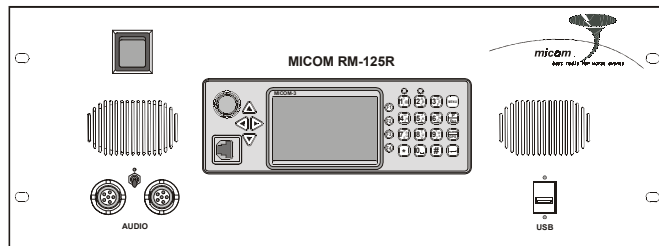

Main Features

- Automatic Link Establishment per FED-1045 & MIL-STD-188-141B standards (JITC certified)
- ISB (Independent Side Band) ready
- Full interoperability with other manufacturers' radios complying with the same ALE standards.

Voice that's loud & clear

- Built-in voice quality system utilizes proprietary algorithms to filter out background noises, giving users exceptional communication clarity.
- Selectable bandwidth allows fine tuning for optimal voice and data communications.
- Voice-activated digital squelch.

User-friendliness

- New control head features a large LCD, full-dot matrix digital display and an enhanced keyboard for programming and set-up.
- Radio operation can be executed using any standard USB keyboard.
- Multiple language display available.
- Transceiver can be controlled using PC and programming application.
- Remote control configuration, allows the transceiver to be operated from a remote location (at a distance of up to 5 km) using the optional 2-wire remote control head.

Years of trouble-free, most advanced communications

- Upgrading to future technologies easily done by installing new software into the transceiver's DSP unit.
- Easily replaceable digital components ensure cost-effective maintenance.
- Very high MTBF, as with all MICOM radios.
- Unique Built-In self Test (BIT) system provides exceptional dependability.
- Protection circuits enable transmission at maximum safe power

Comprehensive communication and networking services

- Office-quality communication services integrating fax, e-mail and data transmission and reception.
- MultiNet option, enables integration of different HF radio networks into one seamless network, allowing excellent coordination between different operational nets.
- AMD (Automatic Message Display) for free and pre-set text messages.

A proven family of radio products

- RM125 and RM125R are members of the MICOM transceiver family – fixed and mobile stations – covering the long-range wireless communication needs of thousands of organizations worldwide.

Major Accessories

- Antenna system and grounding kit
- 1 kW linear power amplifier
- Pre/Post-Selector (PPS)
- ATUs
- FM to HF repeater
- Automatic telephone interconnect
- HF modems
- Secure voice and data
- Vocoder

Performance Specifications

Main Technical Characteristics

This section presents the main technical characteristics of the RM125 and RM125R. For a listing of the additional performance specifications, refer to the “Owner’s Guide, MICOM-3E/3T/3R HF-SSB Transceivers”, Publication 6886867J01, and to the applicable MICOM-3 Supplements that cover the optional features available on your radio set.

| | | |
|-------------------|--|--|
| Models | <i>RM125</i> | M91AMN0KV5-K with G638 |
| | <i>RM125R</i> | M95AMN0KV5-K with G638 |
| General | <i>Number of channels</i> | 200 |
| | <i>Transmission frequency range</i> | 1.6 to 30 MHz |
| | <i>Transmit power (PEP and average)</i> | User-selectable levels <ul style="list-style-type: none">• Max: 125W• High: 100W• Medium: 62.5W• Low: 25W |
| | <i>Reception frequency range</i> | 100 kHz to 30 MHz |
| | <i>Sensitivity (SINAD)</i> | 0.3 μ V for 10 dB SINAD |
| | <i>Audio bandwidth</i> | 350 to 2700 Hz |
| | <i>Data bandwidth</i> | 300 to 3300 Hz |
| | <i>Frequency stability</i> | 0.6 ppm (0.1 ppm optional) |
| | <i>Frequency resolution</i> | 10 Hz |
| | <i>Number of accessories connectors</i> | 4 (see Table 1) |
| | <i>Operating voltage</i> | <ul style="list-style-type: none">• 110 /220 VAC, 50/60 Hz, with automatic switching• 13.8 VDC nominal from external battery or DC power source |
| | <i>Power requirements</i> | <ul style="list-style-type: none">• Maximum 28 A from DC source• Maximum 500W from AC source (without charging) |
| | <i>External battery</i> | Lead-gel or lead-acid, 13.8 VDC, max. 45Ah |
| | <i>Operating temperature range</i> | -10°C to +60°C/14°F to +140°F |
| <i>Humidity</i> | Up to 95% relative humidity @ 50°C/122°F | |
| Dimensions | See Figure 2 | |

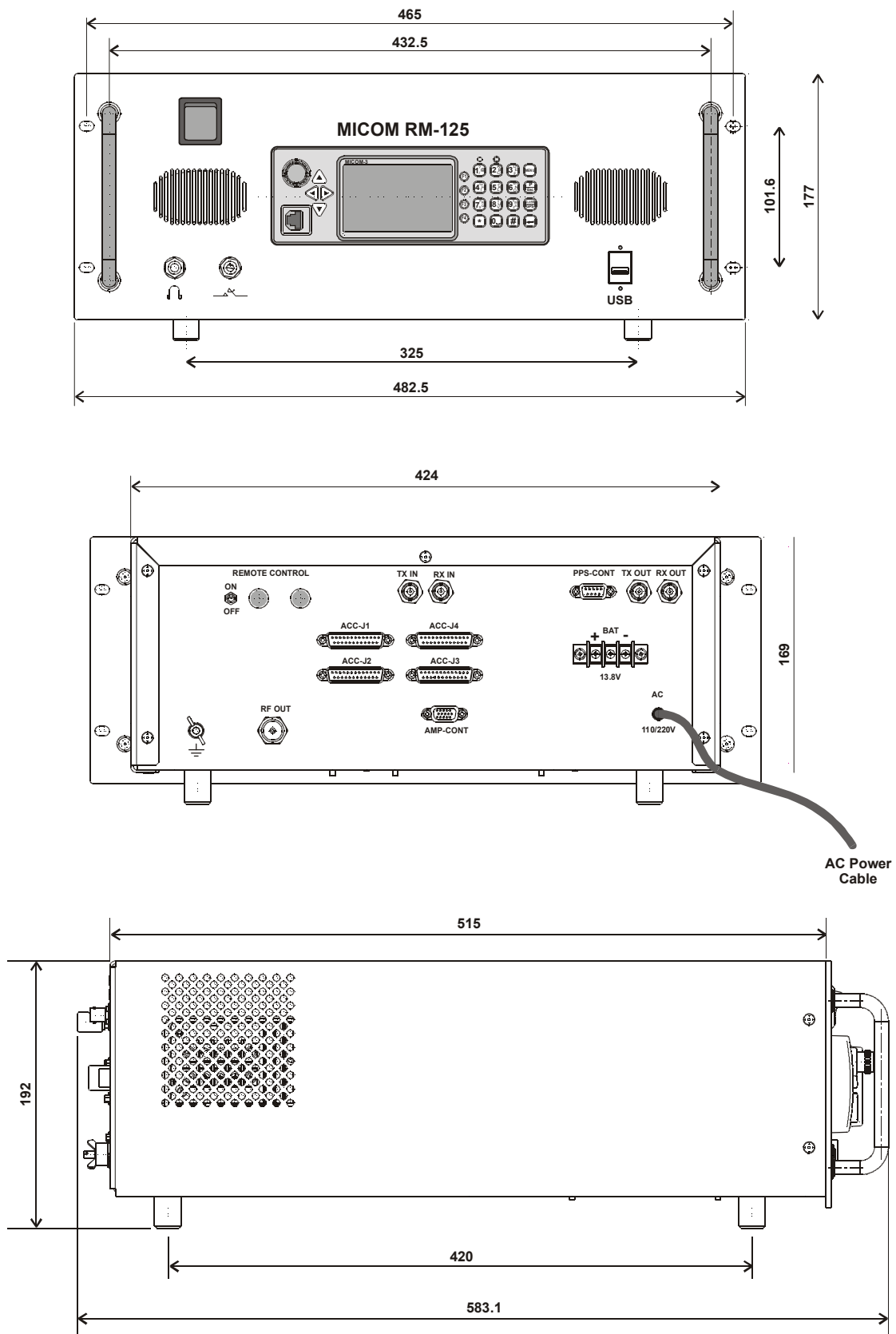

Figure 2. RM125/RM125R Dimensions

Accessories Connectors

The functions of the 25-pin accessories connectors, ACC-J1 to ACC-J4, are listed in Table 1. The connectors include PTT and CW control lines, audio and baseband lines for external equipment, auxiliary power output, serial RS-232 asynchronous data interfaces, and additional dedicated handshaking and control lines. The functions supported by the serial data interfaces are determined by the RM125/RM125R software.

Table 1. 25-Pin Accessories Connector, Pin Functions

| Pin | Designation | Description |
|-----|----------------|---|
| 1 | SPKR- | Differential output to the external 8Ω, 8W speaker |
| 2 | EXT RX DATA- | Baseband output (0 dBm, 600 Ω) |
| 3 | SPKR+ | Differential output to the external 8Ω, 8W speaker |
| 4 | EXT RX AUDIO+ | Differential received audio output (0 dBm, 600Ω; not controlled by volume, but affected by squelch) |
| 5 | EXT RX AUDIO- | |
| 6 | EXT TX AUDIO+ | Differential transmit audio input (600Ω input impedance; 0 dBm is required for full power) |
| 7 | EXT TX AUDIO- | |
| 8 | PTT IN VOICE | Transmission command (short to ground) for voice signals |
| 9 | PTT IN DATA | Transmission command (short to ground) for data signals |
| 10 | PTT IN CW | Transmission command (short to ground) for CW (Morse) signals |
| 11 | SW A+ | Primary DC voltage current limited output (max 1A) |
| 12 | DSI/KW C C | BDM – Data serial in/kW amplifier channel change |
| 13 | KW ON/OFF | kW amplifier power on/off output |
| 14 | EXT RX DATA+ | Baseband output (0 dBm, 600 Ω) |
| 15 | RXA | Receive input (point-to-point protocol to host/HLC) |
| 16 | TXA | Transmit output (point-to-point protocol to host/HLC) |
| 17 | EX RESET | External RESET input (for BDM) |
| 18 | GND | Ground |
| 19 | KW PTT | PTT output to kW amplifier |
| 20 | EXT ALARM | External alarm output (open collector, pulled to ground when external alarm is activated) |
| 21 | VPP | Flash programming voltage, input to BDM |
| 22 | DSC/KW_ALC | BDM – Data serial clock/kW amplifier ALC |
| 23 | SQ GATE | Squelch open/closed indication output |
| 24 | DSO/FAN ON/OFF | BDM – Data serial out/Fan control |
| 25 | FREEZE/KW TU | BDM – Freeze/kW amplifier tune |

Ordering Options

| | | |
|----------------|----------|---|
| G424 (FVN4841) | Add | PC control and programming software package |
| S809 (FLN2515) | Enhanced | Interface cable kit for CW key & headphones |
| G112 | Enhanced | High frequency stability option (0.1 ppm) |
| G849 | Add | Interface option for external voice privacy device (VP-116) |
| G419 | Enhanced | USB COM port for connecting external keyboard |
| G423 | Add | ALE DTM/DBM (data transfer message/data block message) |
| S308 (FLN2517) | Add | Interface cable kit for phone patch |
| G561 (FLN2530) | Add | Interface cable for MICOM link unit |
| G65 | Add | Interface for Pre/Post-Selector (PPS) for co-site and split-site applications |
| G420 | Add | 2-wire remote control head |
| G156 | Add | Interface cable kit for MICOM RM1200 1 kW linear amplifier |
| FLN3175 | Add | MICOM RM1200 1 kW (PEP and average) continuous duty linear amplifier unit |

Familiarization with Equipment

Front Panels

The front panels of the RM125 and RM125R include a standard MICOM-3 control panel and the additional items identified in Figure 3, respectively Figure 4.

For a description of the MICOM-3 control panel, refer to the “Owner’s Guide, MICOM-3E/3T/3R HF-SSB Transceivers”, Publication 6886867J01.

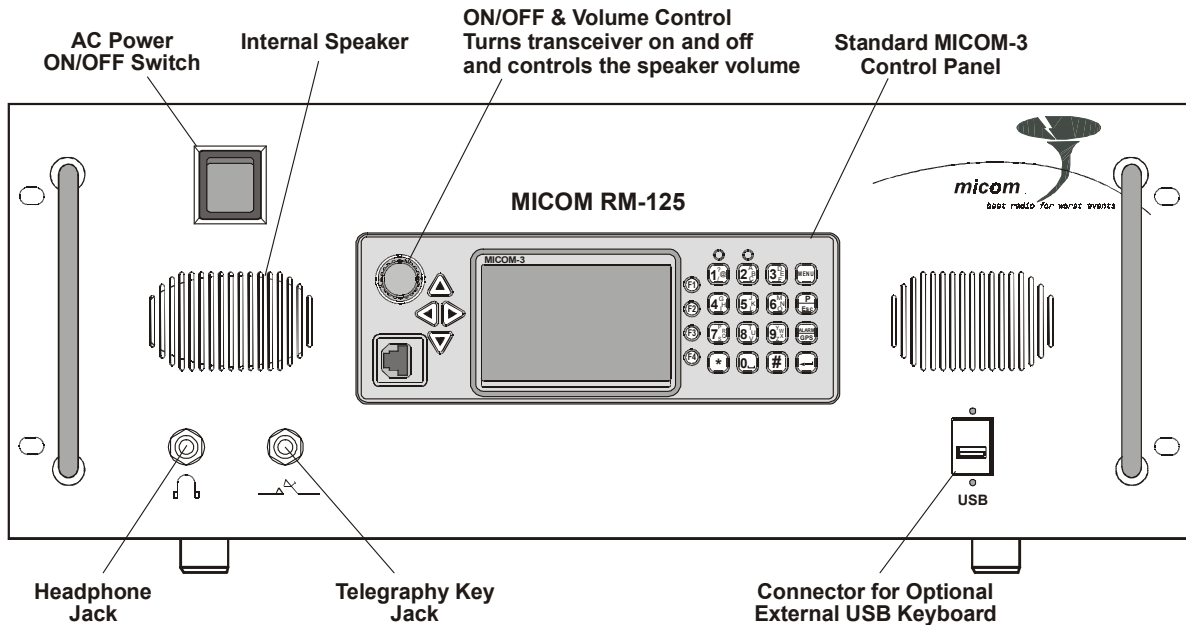

Figure 3. RM125 Front Panel

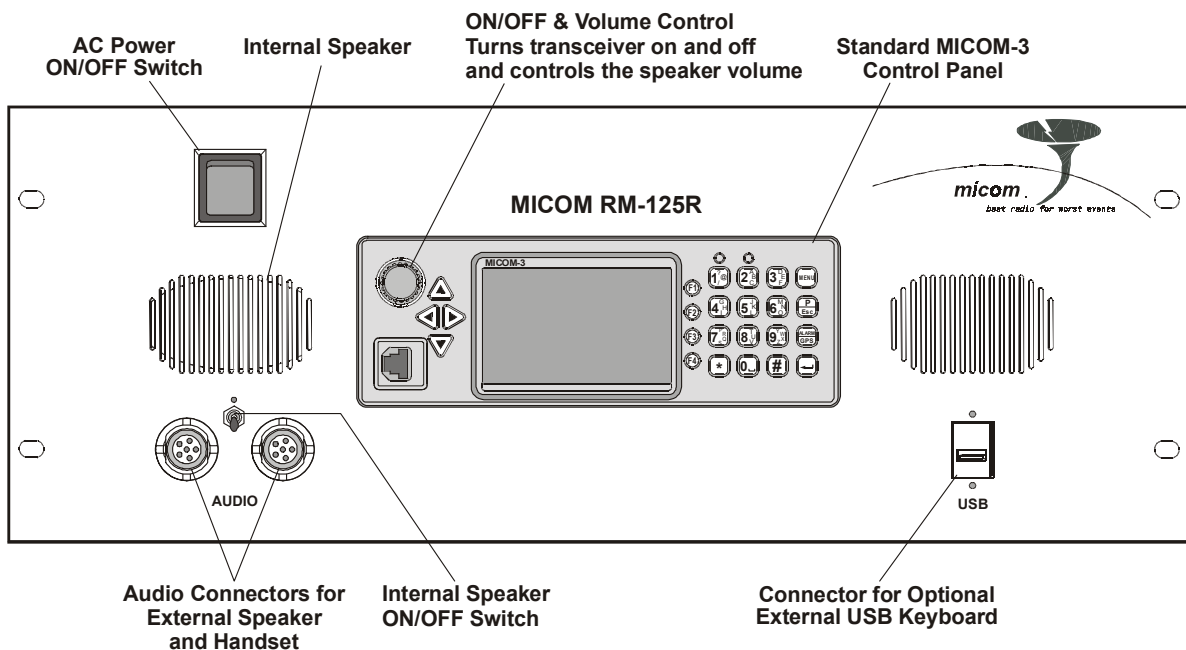

Figure 4. RM125R Front Panel

RM125/RM125R Rear Panels

Figure 5 shows the rear panel of the RM125 and RM125R. The functions of the various items are explained in Table 2.

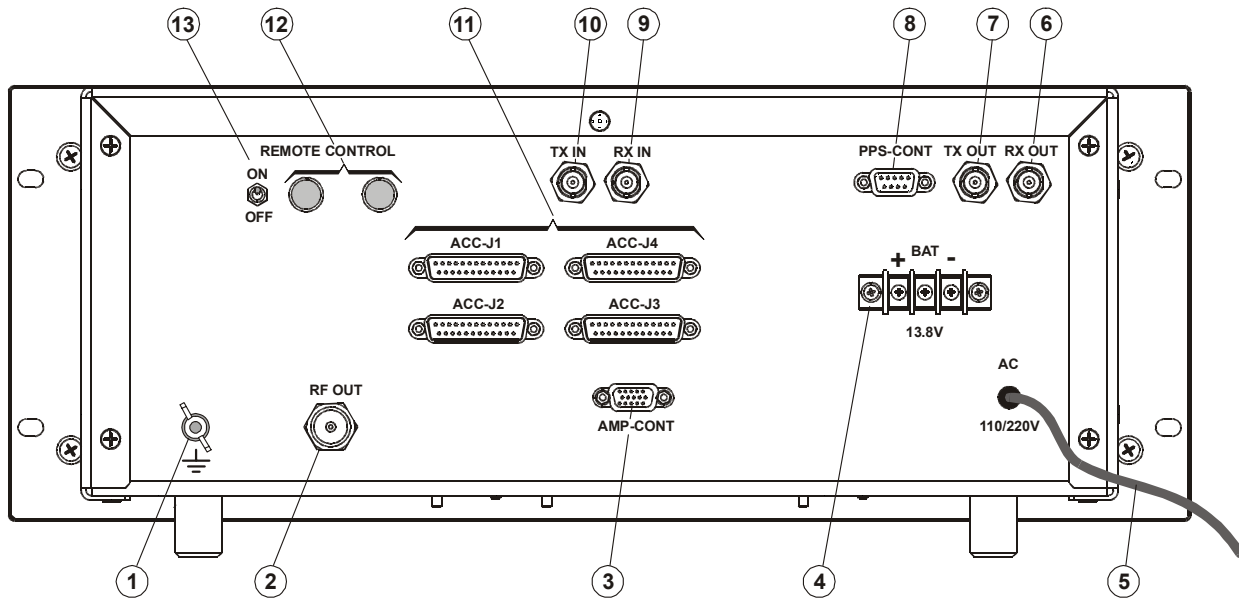

Figure 5. RM125/RM125R Rear Panel

Table 2. RM125/RM125R Rear Panel Items

| Item | Description | Function |
|------|-----------------------------|---|
| 1 | Grounding Screw | Connection of ground to the RM125/RM125R |
| 2 | RF OUT Connector | UHF connector for connection of feed cable to antenna. Serves as the radio set RF input in the receive mode, and as the RF output in the transmit mode |
| 3 | AMP-CONT Connector | 15-pin D-type male connector, for connection of control signals to the 1 kW power amplifier, RM1200 |
| 4 | DC Connection Strip | Connection to external 13.8 V rechargeable lead-gel or lead-acid battery, or input for 13.8 VDC from external power source (via series protection diode and fuse) |
| 5 | AC Power Cable | Connection to 110/220 VAC power source |
| 6 | RX OUT Connector | BNC RF output connector, for connection of unfiltered RF receive signal to the optional Pre/Post-Selector (PPS) |
| 7 | TX OUT Connector | BNC RF output connector, for connection of unfiltered RF transmit signal to the optional Pre/Post-Selector (PPS) |
| 9 | PPS-CONT Connector | 9-pin D-type female connector, for connection of control signals to the optional Pre/Post-Selector (PPS) |
| 11 | ACC-J1 to ACC-J4 Connectors | Four 25-pin D-type male connectors, for connection to external options, for example, voice privacy devices, modems, vocoders, etc. Connector ACC-J2 is used for connection to the parallel I/O interface of the optional Pre/Post-Selector (PPS) |

Table 2. RM125/RM125R Rear Panel Items (Cont.)

| Item | Description | Function |
|------|--------------------------|---|
| 11 | TX IN Connector | BNC RF input connector, for connection of filtered RF transmit signal from the optional Pre/Post-Selector (PPS) |
| 12 | REMOTE CONTROL Terminals | Connection of 2-wire line to optional 2-wire control head |
| 12 | RX IN Connector | BNC RF input connector, for connection of filtered RF receive signal from the optional Pre/Post-Selector (PPS) |
| 13 | REMOTE CONTROL Switch | Enables/disables remote control by the optional 2-wire control head |

RM125/RM125R Installation



Warning

For general operating and installation safety information, see the “Owner’s Guide, MICOM-3E/3T/3R HF-SSB Transceivers”, Publication 6886867J01.

During installation work, strictly observe the applicable safety precautions and local regulations. Do not work on the antenna system during lightning storms.



Warning

Proper grounding is essential for your safety, and for good communication performance.

Do not touch the antenna and the RF connectors while the radio set operates. During transmission, high RF voltages appear at the RF connectors, the antenna cables, and on the antenna itself. These voltages may cause severe injury or death on contact.

Make sure the antenna is not located near high-voltage lines.

All personnel must be familiar with the applicable safety requirements before attempting to install or operate the radio set. Severe injury or death could result from failure to comply with the safety practices.

Installation Planning Guidelines

This section provides information necessary for planning the installation of RM125/RM125R.

Grounding

Failure to provide proper grounding will degrade system operation and cause RF voltage to be present on the equipment chassis. A possible serious hazard to personnel could result, as well as equipment malfunction.

Wide copper straps, as short as possible, must be used for grounding. These straps must be clamped or bonded to a reliable, low-resistance grounding system.

AC Power Requirements

The RM125/RM125R requires AC power at a nominal voltage of 110 or 220 VAC, 50/60 Hz. The RM125/RM125R will automatically select the appropriate voltage range.

The maximum AC power consumption during high-power transmission (excluding the charging of an external battery), is 500W.

A suitably rated circuit breaker or fuse must be used to protect the supply line to the RM125/RM125R, and enable disconnection of supply voltage during installation and maintenance.

DC Power Requirements

The RM125/RM125R can also operate from an external 13.8 VDC source, connected to its BAT terminals. Two types of DC sources may be used:

- 13.8 V rechargeable battery serving only the RM125/RM125R and charged by its internal power supply. The charging current is provided to the battery whenever operating from AC, therefore the battery is kept fully charged. Connecting an external battery has the advantage that the transceiver can be used even during AC power failure. See battery requirements in the *Internal Charger Requirements* section below.
- Central 13.8 VDC source available at the base station. This enables using the power arrangements available on-site, without requiring AC power to be supplied to the transceiver. In this case, the connection to the DC source must be made through customer-provided series protection diode with suitable current and surge ratings, and 30 A fuse.

Internal Charger Requirements

The RM125/RM125R can supply charging current to a 13.8 V battery connected to its BAT terminals. Only 13.8 V lead-gel or lead-acid batteries with a maximum capacity of 45 Ah may be used. The connection to the DC source must be made through a customer-provided 30 A fuse.

Note that the transceiver draws current from the battery even the transceiver is switched off. Therefore, it is recommended to disconnect the transceiver from the battery if the radio is not used for prolonged periods.

Cooling

RM125/RM125R units are cooled by internal fans. Air is taken in through the front panel vent, and discharged toward the rear. Therefore, make sure that sufficient free space is available around the equipment to enable free air flow.

Do not stack equipment units: leave at least 1U free above and below the RM125/RM125R.

Installation Data

The RM125/RM125R are intended for installation on desktops or in 19" racks. The equipment has front-mounted brackets for attachment to the rack. To provide convenient access during maintenance, the RM125/RM125R may be installed in a sliding drawer or on slides capable of supporting the equipment weight.

Make sure that sufficient rack space is available for installation of other options, for example, the 1U-high Pre-Selector/Post-Selector (PPS).

The rack must be connected to a reliable, low-resistance grounding system.

Sufficient front and rear clearance is required to permit convenient access to front and rear panels, as well as for removal and installation of equipment units, connection of cables, and maintenance.

Antenna System

Antenna systems are selected in accordance with the specific communication requirements of each customer: many HF antenna types are available, each providing different radiation characteristics to meet different communication requirements. Therefore, the selection and installation of an antenna system is customer's responsibility. If necessary, contact the manufacturer or your local representative for additional information.

The antenna system must provide a matched termination at the operating frequency, and must be capable of handling the maximum power output of the RM125/RM125R.

Antenna Feed System

The antenna feed system comprises any cables, panels and matrices, and any accessories that carry HF signals between the RM125/RM125R and the antenna itself.

All the antenna feed system components, and in particular the feed cable, must have low loss and be capable of carrying the maximum power output of the RM125/RM125R. Remember that any power loss along the cable is signal loss!

To protect yourself and the radio equipment against lightning strokes and accidental contact of antenna and/or feed cable with high voltage lines, a properly grounded coaxial protector must be installed at the point of entry of the feed cable into the building or communication shelter. The recommended protector type is IS-B50LN-C0 by PolyPhaser Corp. (also available from Mobat, as Cat. No. 2072-09128-00).

Preparations for Installation

Before starting the installation of a new RM125/RM125R, review the installation plan and make the following checks:

1. Identify the prescribed location of the equipment in the rack or cabinet.
2. Check the mounting surface, and the mounting holes. Thoroughly clean the mounting surface and remove all paint, grease and dirt from the holes to provide a better grounding connection.
3. Check availability of AC and/or DC power, and grounding arrangements.
4. Check antenna installation, in accordance with the antenna installation and operation manual.
5. Check the cable runs between the RM125/RM125R and the prescribed antenna, including the coaxial protector. Make sure that the cables are securely fastened, and do not show signs of external damage.



Caution

Before installing the RM125/RM125R on slides, make sure you are familiar with the procedures needed to install slides in the rack/cabinet, and to safely install heavy equipment on the slides.

Installation Procedure – Basic Radio

Preliminary Connections

1. Identify the installation position of the RM125/RM125R in the rack.
2. Install the RM125/RM125R in the prescribed installation position, fastening it by means of four screws to the rack rails or to the drawer front.
3. Connect grounding straps from each of the two RM125/RM125R grounding screws (located on its rear panel), to the prescribed cabinet's grounding bar.
4. Set the AC power switch on the RM125/RM125R front panel to OFF (down position).
5. Turn the ON/OFF and volume control fully counterclockwise, beyond the detent position.
6. Connect cables to the unit as follows:
 - Connect the RM125/RM125R AC power cable to the prescribed outlet on the power distribution box of the cabinet.

- Connect the antenna feed cable to the RF OUT connector of the RM125/RM125R.
- When an external device is used, connect the prescribed cable to the accessories connector of the RM125/RM125R that supports the corresponding device.

7. Connect audio accessories to the front panel connectors.

DC Connections

The RM125/RM125R may be connected to DC sources, as explained in the *DC Power Requirements* section (page 12).

Figure 6 shows the connections to an external 13.8 VDC lead-gel or lead-acid battery, and Figure 7 shows the connections to an external DC power source. As the arrangements needed for these connections depend on the specific site, all the accessories required for the connections shown in these figures must be provided by the customer.

Note that the transceiver draws some current from the DC source (battery or site power) even when it is switched off, and therefore you should connect the transceiver to the battery only when ready to start using it.

You should also make arrangements to disconnect the battery if the radio is not used for prolonged periods.



Caution

Risk of explosion if incompatible battery is used or battery is connected with incorrect polarity!

Do not make connections to the BAT terminals when the RM125/RM125R is turned on and powered from AC.

1. Before starting, make sure that the AC power switch on the RM125/RM125R front panel is set to the OFF (down) position.
2. Refer to Figure 6 or Figure 7, as appropriate and start by making the connection to the negative (-) BAT terminal of the RM125/RM125R.
3. Make the connection between the external battery or DC power source to the positive (+)BAT terminal.

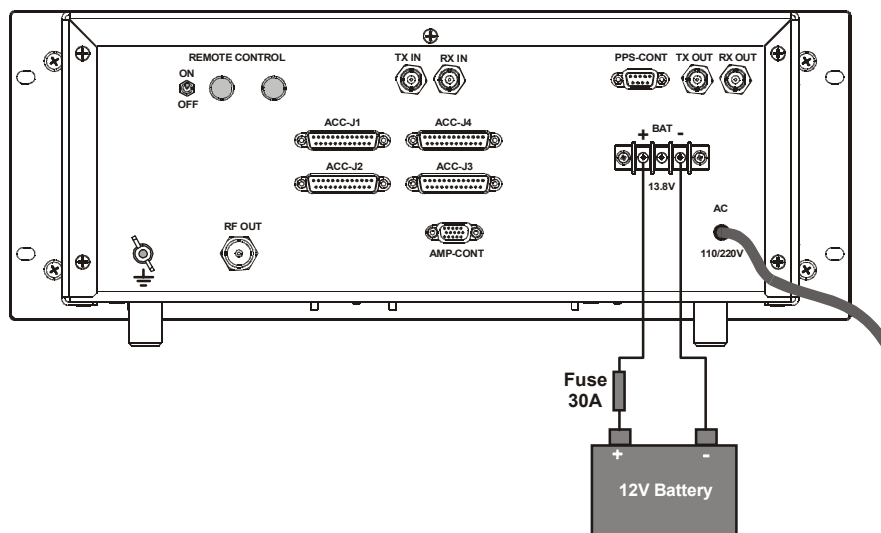

Figure 6. RM125/RM125R Connections to External Battery

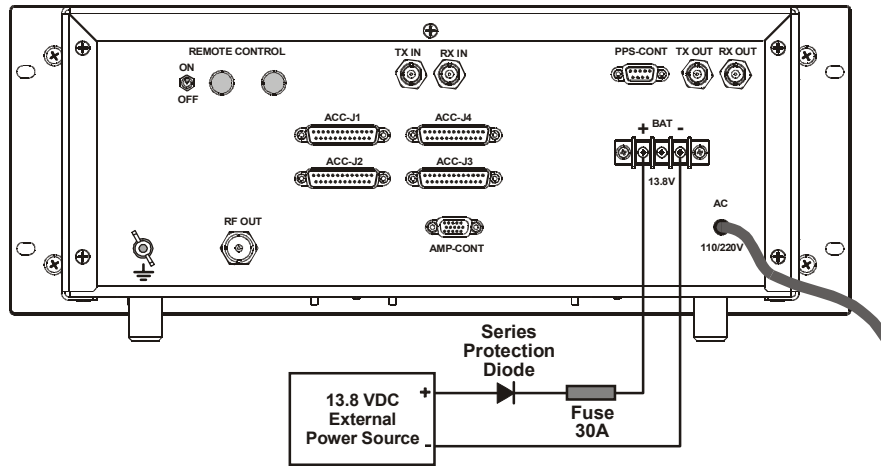

Figure 7. RM125/RM125R Connections to DC Power Source

Installation Procedure – Radio with PPS Option

PPS Functions

The optional Pre-Selector/Post-Selector, PPS-100, supported as an option by the RM125/RM125R, permits operation of collocated receivers and transmitters on frequencies separated by as little as 10%. The PPS operating frequency range is 1.60 to 29.99 MHz.

To use the PPS, order the RM125/RM125R with option G65. The connections between an RM125/RM125R with option G65 and the PPS are shown in Figure 8.

When the G65 option is installed, the PPS is controlled by the RM125/RM125R through serial and parallel ports and is automatically inserted by the RM125/RM125R in the signal path in accordance with the operating mode:

- In the receive mode, the PPS functions as a preselector, providing an additional front end selectivity stage for the receive path of the RM125/RM125R. This reduces the receiver desensitization and overload that would normally occur in the presence of strong adjacent RF transmissions.
- In the transmit mode, the PPS is used as a postselector. It attenuates spurious signals and broadband noise in the driver transmit signal before it reaches the internal RF power amplifier, thereby reducing interference to neighboring receivers.

In both modes, the PPS automatically tracks the RM125/RM125R operating frequency. Rapid tuning makes the PPS suitable for Automatic Link Establishment (ALE) or Adaptive Applications.

During the power-up self-test, the PPS automatically switches to the bypass mode: in this mode, RF signals pass directly through the PPS, without filtering, and therefore it does not interfere with system operation. The PPS also switches to the bypass mode when the RM125/RM125R frequency is outside the PPS operating range, 1.60 to 29.99 MHz.

In case excessive RF power is applied to the PPS, the PPS enters the RF overload protection mode: in this mode, the PPS antenna port is disconnected, and the internal antenna input is short-circuited to ground. This also protects the RM125/RM125R internal transceiver against overload.

The PPS is housed in a 1U high (1.75") case intended for 19" rack mounting. Standard operation is from 115 or 230 VAC, 50/60 Hz; the PPS can also be powered from 12 or 24 VDC sources.

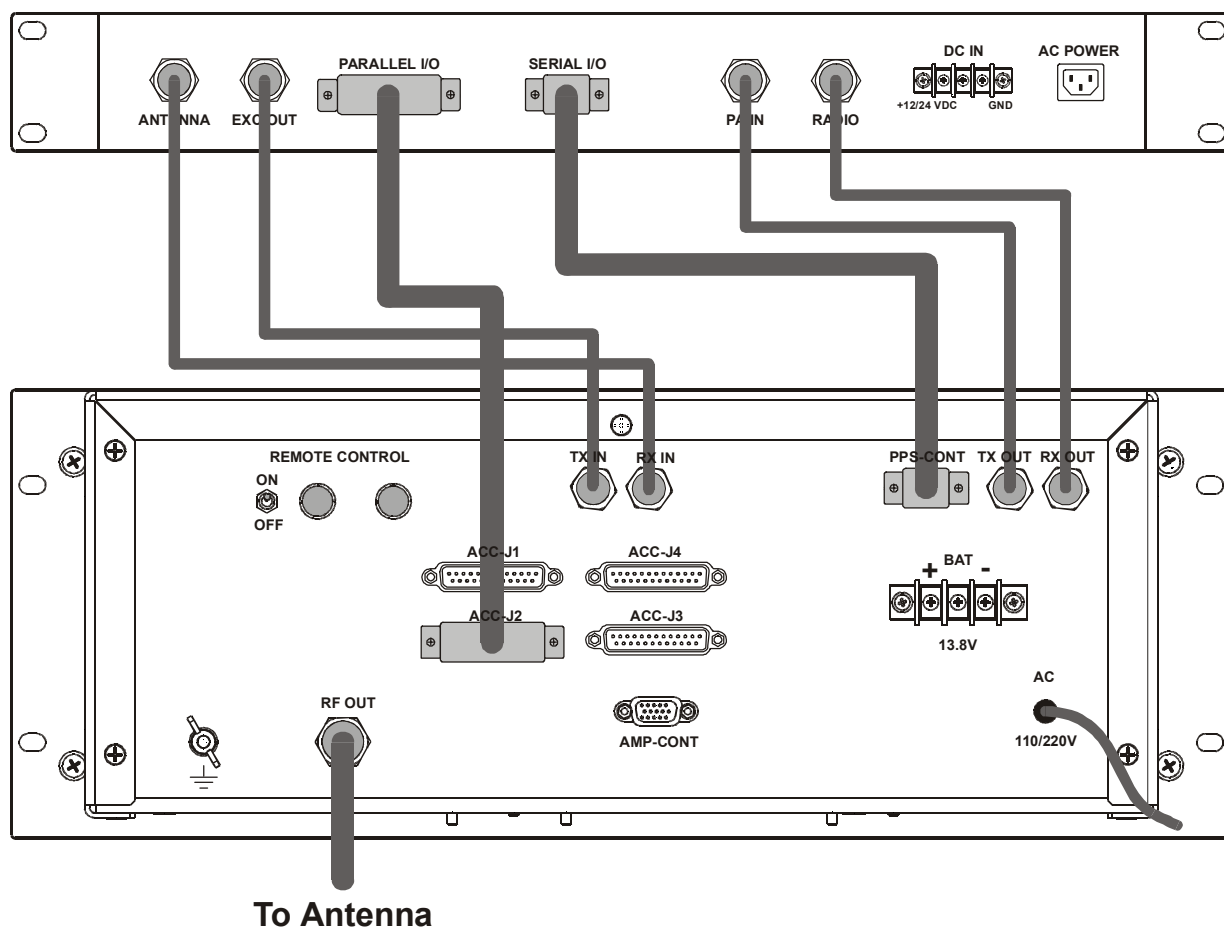

Figure 8. Connections to PPS

PPS Installation Procedure

Note The following procedure assumes that the basic RM125/RM125R unit has already been installed, as explained above (page 14).

1. Identify the installation position of the PPS in the rack, and the position of the RM125/RM125R to which it will be connected.
2. Install the PPS in the prescribed installation position, fastening it by means of four screws to the rack rails or to the drawer front.
3. Connect a grounding strap from the RM125/RM125R grounding screw to the prescribed cabinet's grounding bar.
4. Set the power switches on the RM125/RM125R and PPS front panels to OFF (down position).
5. Connect the PPS AC power cable to the prescribed outlet on the power distribution box of the cabinet.
6. When the PPS is powered from DC, connect the DC lines to the DC IN terminals on the PPS rear panel. Pay attention to correct polarity!
7. Refer to Figure 8 and connect cables between RM125/RM125R and the PPS as follows:

| RM125/RM125R Connector | PPS Connector |
|-------------------------------|----------------------|
| PPS-CONT | SERIAL I/O |
| ACC-J2 | PARALLEL I/O |
| RX IN | ANTENNA |
| TX IN | EXEC OUT |
| TX OUT | PA IN |
| RX OUT | RADIO |

This completes the installation of the PPS.

RM125/RM125R Operation

General

The following instructions present operating procedures specific to the RM125 and RM125R. It is assumed that the operator is familiar with the common MICOM-3 operating procedures; if necessary, refer to the “Owner’s Guide, MICOM-3E/3T/3R HF-SSB Transceivers”, Publication 6886867J01, and to the applicable MICOM-3 Supplements that cover optional features.

Preparations for Operation

1. Set the REMOTE CONTROL switch on the rear panel of the RM125/RM125R to the OFF (down) position.
2. For the RM125R, set the internal speaker switch to ON (up).

Operating Instructions

1. Apply power to the RM125/RM125R by setting its main switch to ON (up).
2. Turn the ON/OFF switch and volume control clockwise and adjust for a comfortable listening level.
3. You are now ready to start using the RM125/RM125R. For operating procedures, you may use the information appearing in the “Owner’s Guide, MICOM-3E/3T/3R HF-SSB Transceivers”, Publication 6886867J01.
4. To turn the radio off, set its main switch to OFF (down), and then turn the ON/OFF switch and volume control fully counterclockwise, beyond the detent position.

RM1200 1 kW Power Amplifier Option

1 kW System Description

The RM1200 1 kW power amplifier option, FLN3175, which uses the RM125/RM125R as an exciter, expands the MICOM-3 product line by offering higher transmit power (up to 1 kW, PEP and average), and thus longer reach and improved communications under bad propagation conditions and/or strong interference. RM1200 consists of two units intended for rack mounting, together with the RM125/RM125R: 1 kW RF linear power amplifier and AC-powered PS unit. The equipment is well suited for base station applications, and can be directly connected to a wide range of broadband or tuned antennas, including whip, dipole, traveling wave, delta, and semi-delta antennas.

Upon power-up, the RM1200 uses a low-level RF pilot signal from the exciter to automatically detect the incoming frequency and select the optimum harmonic filter band in accordance with the operating frequency. The frequency detection and filter switching is quite rapid, a capability needed for ALE and adaptive communication modes.

The equipment is optimized for operation in conjunction with the RM125/RM125R radio set as exciter and controller, using a dedicated communication interface and a flexible handshaking protocol (to use these capabilities, order the special interface cable kit, option G156, for connecting the 1 kW amplifier to the RM125/RM125R). The RM125/RM125R controls the 1 kW amplifier operation, enables the operator to select the nominal transmit power, and the 1 kW amplifier provides ALC feedback to adjust the RM125/RM125R drive power to the optimum level.

Although optimized for operation with the RM125/RM125R, RM1200 can be used with any HF-SSB driver capable of providing the required drive power (approx. 40W), and appropriate interfacing. Contact the manufacturer for details on the RM1200 interfacing requirements.

Protection circuits monitor the various operating conditions, and prevent damage to the 1 kW amplifier by taking appropriate action, in accordance with the detected problem.

The 1 kW amplifier has several status indicators, and a front-panel LCD that enables the operator to monitor the RM1200 operation. This LCD can be used to read the actual forward and reflected power (or VSWR), and report problems such as the activation of protection circuits or technical malfunctions. The LCD and the status indicators indicate the type of problem that has been detected, thus helping the operator correct it.

In addition, the 1 kW amplifier has a serial RS-232 asynchronous interface that can be used for maintenance and calibration: the program needed to use this interface is stored in the 1 kW amplifier, and therefore any data communication terminal (or PC emulation program, for example, the HyperTerminal utility available on PCs running under Microsoft Inc. Windows®) can be used.

The 1 kW amplifier is active only in the transmit mode: when not powered, in the receive mode, and also after the protection circuits are activated, the 1 kW amplifier switches to the bypass mode, and directly connects the radio set to the antenna system.

Functional Description

1 kW Amplifier

The 1 kW amplifier consists of the following main functions:

- Linear RF power amplifier covering the HF band. The RF amplifier consists of 4 independent amplification modules, whose outputs are combined to obtain the required RF output power. The RF drive signal, applied to the RF IN connector, is amplified to the appropriate level, as selected on the RM125/RM125R.
- Harmonic filter. This is a low-pass filter whose purpose is to attenuate harmonics and other undesired signals at frequencies above the actual operating frequency, before the amplified output signal is applied to the RF OUT connector. The filter has 8 sub-bands: the filter that fits the operating frequency is automatically inserted in the transmit path. The required frequency information is received from the RM125/RM125R; in addition, the 1 kW amplifier measures the actual frequency of the RF drive signal as part of its tuning process (if the frequency cannot be measured, the highest band is selected).
- Bypass circuits. These circuits automatically bypass the 1 kW amplifier and establish a direct path between the RF IN and RF OUT connectors when power is not available, or a critical malfunction is detected.
- Control circuits. These circuits control 1 kW amplifier operation, interface with the driver (RM125/RM125R), and take action to protect the amplifier when necessary.
- Cooling subsystem, includes internal fans that enable operation over a wide range of temperatures.

Overdrive Protection

The 1 kW amplifier requires a nominal drive power of approx. 40W. When operating the 1 kW amplifier with the RM125/RM125R as driver, the input power is automatically adjusted by an automatic level control to achieve optimal operating conditions for the amplifier.

However, if the input drive power exceeds about 80W (either because incorrect setting of the operating conditions when using another's vendor's driver, incorrect connections or other possible faults), the protection circuits prevent damage to the 1 kW amplifier by bypassing it.

High VSWR Protection

To obtain maximum forward power, the RM1200 should be connected to a low VSWR antenna system. In case of excessive VSWR, for example, because of mismatch or damage to antenna system and/or feed cables, the ALC circuits prevent damage by reducing the transmit power to safe values. Thus, the RM1200 will always attempt to transmit at the maximum safe power in case of mismatch.

However, in case of excessive mismatch (for example, short or open circuit), the protection circuits switch the 1 kW amplifier to the bypass mode: in this case, the transceiver is directly connected to the antenna. This enables normal reception, as well as transmission, albeit at the lower power levels an RM125/RM125R (or the transceiver used as exciter) can provide.

1 kW Amplifier Overheating Protection

Special circuits protect the 1 kW amplifier against overheating. If the temperature is too high to enable full-power operation, the output power is automatically halved, until the temperature returns to normal.

However, if the temperature exceeds the maximum allowed limit and damage may be caused, the protection circuits are activated and bypass the amplifier.

Imbalance Protection

When a fault, power failure or other type of failure prevents normal operation of one or more of its internal amplification modules, the 1 kW amplifier is automatically bypassed.

PS Unit

The PS unit, type YM-02-670B, is manufactured by Lambda Inc. See its manufacturer's manual for complete information.

The unit is a 110/220 VAC, 50/60 Hz AC-powered power supply contained in a compact chassis suitable for installation in 19" racks. The AC input voltage range is automatically switched between 110 and 220 VAC, and therefore the equipment can be used in the United States of America as well as in other countries. Internal cooling fans enable operation over a wide range of temperatures.

The PS unit includes two independent power supply subsystems, each providing +45V to two of the four amplification modules in the 1 kW amplifier. Protection circuits monitor each output, and provide indications on front panel indicators in case the output voltages deviate by more than 25% from the nominal value; if an output voltage increases beyond the maximum limit, the corresponding power supply subsystem is turned off, to prevent damage to the 1 kW amplifier.

RM1200 Main Technical Characteristics

This section presents the main technical characteristics of the RM1200. If you need additional details, contact the manufacturer or your local representative.

| | | |
|--|---|---|
| General | <i>Operating Modes</i> | <ul style="list-style-type: none"> • Transmit mode (PTT controlled) • Bypass mode (input connector connected to output connector with RM1200 not powered, in the receive mode, or after protection is activated) • Tuning (automatic detection of transmit signal frequency) |
| | <i>Transmit frequency range</i> | 1.6 to 30 MHz |
| | <i>Maximum transmit duty cycle</i> | Continuous transmission |
| | <i>Control and maintenance interfaces</i> | <ul style="list-style-type: none"> • Serial RS-232 asynchronous maintenance port for dumb terminal (control program contained in 1 kW amplifier) • Control and status port for interfacing to the RM125/RM125R as driver |
| | <i>Number of system units</i> | <ul style="list-style-type: none"> • 1 kW RF linear power amplifier • AC-powered PS unit, Lambda YM-02-670B |
| | <i>Exciter type</i> | <ul style="list-style-type: none"> • RM125/RM125R (recommended) • Any HF-SSB radio set capable of providing sufficient drive power and compatible control interface |
| 1 kW Amplifier Electrical Characteristics | <i>Transmit power (PEP and average)</i> | User-selectable: <ul style="list-style-type: none"> • Max: 1000W • High: 800W • Medium: 500W • Low: 300W |
| | <i>Input drive power</i> | 40W nominal, maximum 80W |
| | <i>Nominal input and output impedance</i> | 50 Ω |
| | <i>Intermodulation products</i> | Less than -25 dB below each tone |
| | <i>Non-harmonic products</i> | Less than -60 dB |
| | <i>Harmonics</i> | Less than -50 dB |

| | | |
|---|-------------------------------|--|
| | <i>Load mismatch</i> | <ul style="list-style-type: none"> • Full transmit power for VSWR up to 1.5:1 • Reduced transmit power for higher VSWR (50% down at VSWR of 4:1) • Full protection against short/open circuit |
| | <i>Overheating protection</i> | <ul style="list-style-type: none"> • Reduced transmit power for high temperature • Bypass in case of excessive temperature |
| | <i>Operating voltage</i> | 45 to 48 VDC from PS unit |
| | <i>Power requirements</i> | <ul style="list-style-type: none"> • Maximum 2000W in SSB mode • Maximum 3500W in CW mode |
| | <i>Cooling</i> | Forced air cooling |
| Dimensions | <i>Height</i> | 221 mm/8.7 inch |
| | <i>Width</i> | 482 mm/19 inch |
| | <i>Depth</i> | 492 mm/19.4 inch |
| | <i>Weight</i> | 25 kg/55 lbs |
| PS Unit Main Characteristics (see YM-02-670B manual for full information) | <i>Output voltage</i> | 45 VDC nominal |
| | <i>Operating voltage</i> | 110 /220 VAC, 50/60 Hz, with automatic switching |
| | <i>AC power requirements</i> | Maximum 5000W |
| | <i>Cooling</i> | Forced air cooling |

Familiarization with RM1200 Equipment

1 kW PA Front Panel

Figure 9 identifies the items located on the front panel of the 1 kW amplifier, and Table 3 explains their functions.

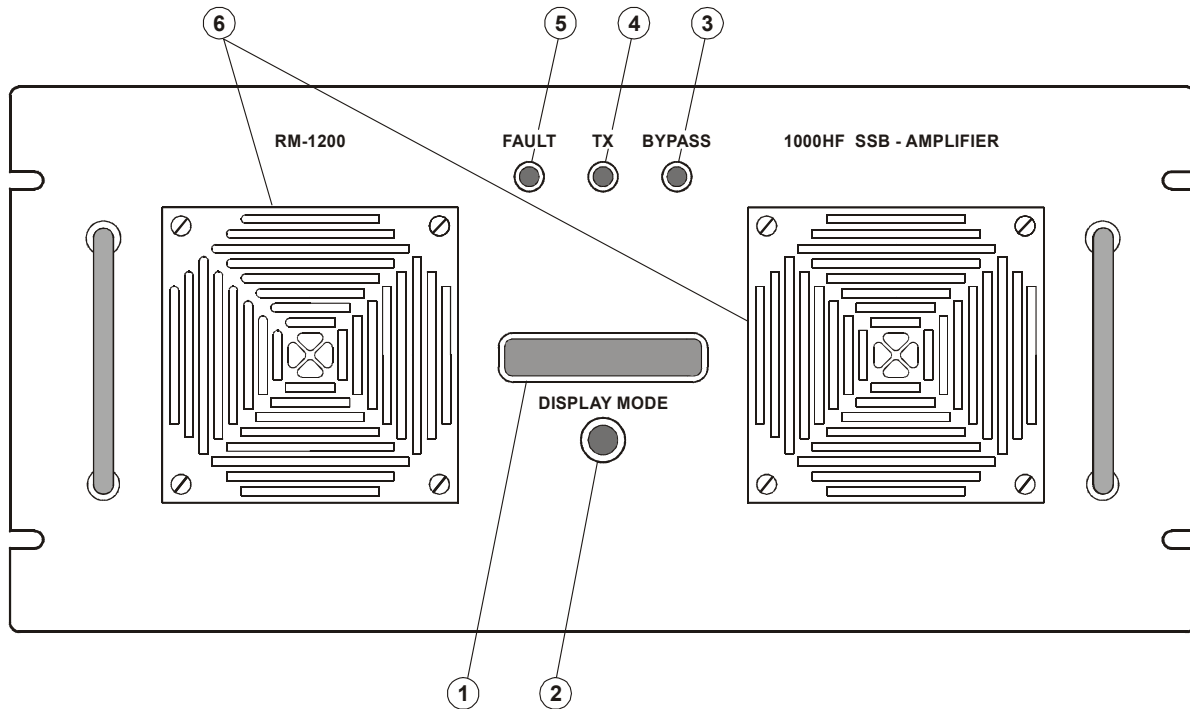

Figure 9. 1 kW PA Front Panel

Table 3. 1 kW PA Front Panel Items

| Item | Description | Function |
|------|--------------------------|---|
| 1 | Display | LCD display. See the following section for displayed information |
| 2 | DISPLAY MODE push-button | Selects the type of information presented on the display |
| 3 | BYPASS indicator | Lights when the 1 kW amplifier is in the bypass mode (in this mode, the RF IN connector is directly connected to the RF OUT connector). The 1 kW amplifier is normally bypassed when the radio is in the receive mode. It is also bypassed when it is not powered, or a fault or abnormal condition prevents its normal operation |
| 4 | TX indicator | Lights when the 1 kW amplifier is switched to the transmit mode |
| 5 | FAULT indicator | Lights when a fault in the 1 kW amplifier does not allow normal operation. In this case, the amplifier remains in the bypass mode until the fault is corrected. Flashes when an operational problem, for example, high temperature or excessive VSWR, activates the corresponding protection circuits and causes the amplifier to reduce its output power or temporarily switch to the bypass mode |
| 6 | Air intake vents | Intake vents for cooling air, with removable covers that provide access to the dust filters |

1 kW PA LCD Functions

The LCD is used to display information on the operational conditions of the 1 kW amplifier, and status information. The LCD comprises 2 rows, and therefore it is necessary to split the information on four different display pages of 2 rows each.

The first row of each page always presents two items:

- The current mode indicator, **RX** or **TX**
- The operating frequency, in MHz, as detected during the tuning process. The frequency is displayed with a resolution of 10 kHz.

The information displayed in the second row changes with the specific page. To select a page, press the DISPLAY MODE push-button display as required (scrolling is cyclical). The selected page remains on display, until you select another page.

The information presented on each page is explained in Table 4. The pages are presented in the order they appear when scrolling by means of the DISPLAY MODE push-button.

Table 4. 1 kW PA LCD Functions

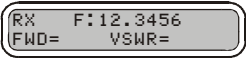
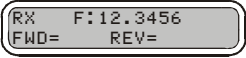
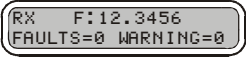
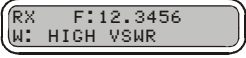
| No. | Typical Page | Function |
|-----|---|---|
| 1 |  | Normal receive screen. When transmitting (TX), the second row displays the forward (FWD) power in watts, followed by the VSWR . |
| 2 |  | Alternative screen: when transmitting, displays the forward (FWD) and reflected (REV) power in watts. |
| 3 |  | Status screen (shown for receive – RX – mode). Displays the total number of faults and warnings detected in the unit. If either number is not 0, the FAULT indicator indicates the condition with the highest severity: <ul style="list-style-type: none"> • If the condition with the highest severity is a warning (FAULTS is 0, WARNING is not 0), the FAULT indicator flashes • If the condition with the highest severity is a fault (FAULTS is not 0), the FAULT indicator lights steadily |
| 4 |  | Fault (F) or warning (W) screen: displays the fault and /or warning detected in the unit. See list of messages that may be displayed in Table 5 |

Frequency appears only after successful tuning: before tuning, and also in case the tuning fails, no frequency is displayed. For example:

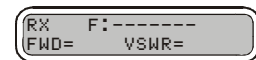

The forward and reflected power (or VSWR) values are automatically updated; fault and warning information is refreshed only after scrolling again to the same page.

Protection circuits are reset after the PTT is released, but may be activated again if condition persists.

Table 5. 1 kW PA Fault and Warning Messages

| Type | Message | Meaning | Corrective Actions |
|---------|--|---|---|
| Fault | AMP#1 AMP#2 AMP#3 AMP#4 | The corresponding amplifier module does not operate, for example, because its supply line fuse is blown, or a fault in the module itself. 1 kW amplifier is in the bypass mode and cannot transmit | Service is required |
| | RF IN OVERLOAD | Excessive drive power supplied to the RF IN input. 1 kW amplifier is in the bypass mode and will not transmit until the condition is corrected | When using the amplifier with a driver other than RM125/RM125R, check the maximum transmit power of the driver unit. When using the RM125/RM125R, first check for proper connection of the control cable between the RM125/RM125R AMP-CONT connector and the 1 kW amplifier EXCITER CONTROL connector. If problem persists, service is required (adjustment of operating conditions using the MONITOR program) |
| | PWR OUT LATCH | Technical problem related to the harmonic filter. 1 kW amplifier is in the bypass mode and cannot transmit | Service is required |
| | TEMP OVERHEAT | Excessive internal temperature. 1 kW amplifier is in the bypass mode and cannot transmit until it cools | Wait for the amplifier to cool. Check that the air intake vents and exhaust vents are free. If condition recurs, power down the amplifier and clean the dust filters (the filters are reached after removing the intake covers, which are fastened by four screws each) |
| Warning | PWR OUT REDUCED | Internal temperature is too high. 1 kW amplifier transmits at reduced (half) power as long as problem persists | See TEMP OVERHEAT |
| | HIGH VSWR | Excessive reflected power. 1 kW amplifier is in the bypass mode and will not transmit until the condition is corrected | Check the antenna feed cable, starting from the RF OUT connector, and up to the antenna. Also check that no damage is evident to the cables and to the antenna itself |

1 kW PA Rear Panel

Figure 10 identifies the items located on the rear panel of the 1 kW amplifier, and Table 6 explains their functions.

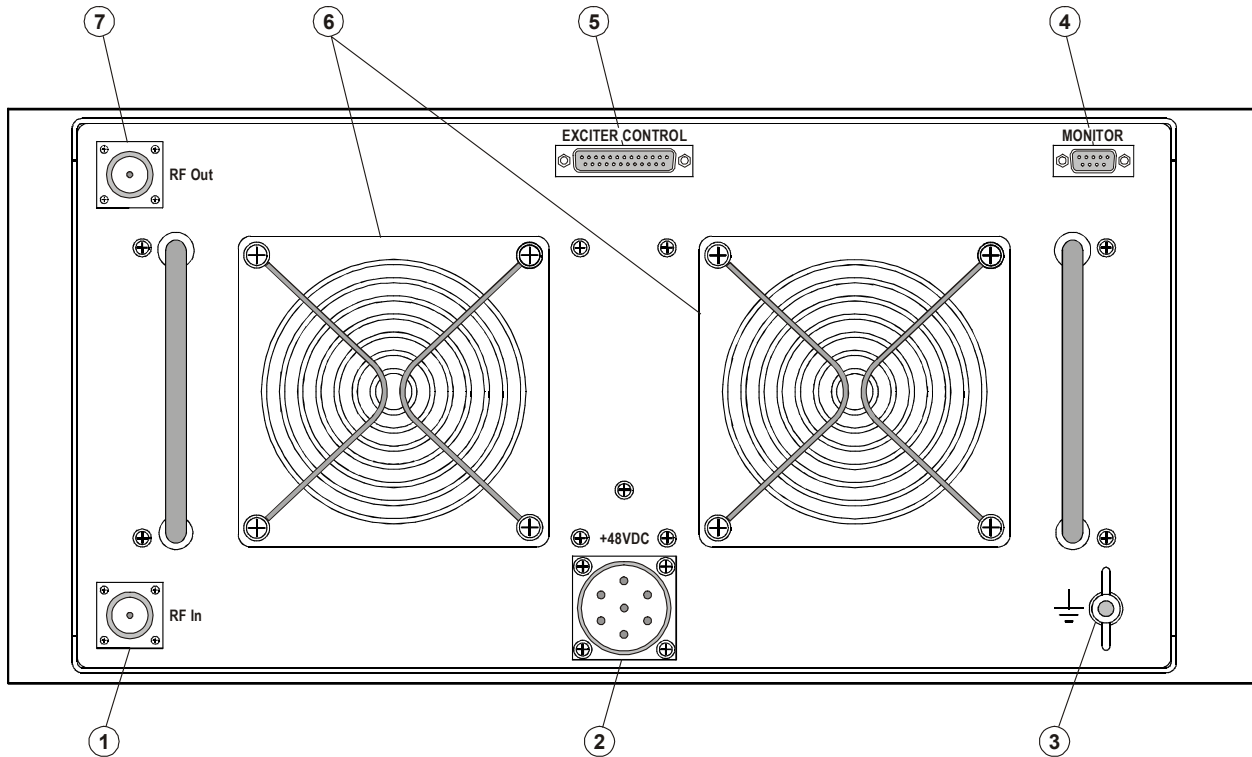

Figure 10. 1 kW PA Rear Panel

Table 6. 1 kW PA Rear Panel Items

| Item | Description | Function |
|------|---------------------------|---|
| 1 | RF IN Connector | N-type connector for RF connection to the RM125/RM125R: <ul style="list-style-type: none"> In the receive or bypass mode, serves as output for receive signals In the transmit mode, serves as input for RF drive signals |
| 2 | +48VDC connector | 7-pin circular connector for connection to DC power source |
| 3 | Grounding screw | Connection of ground to the 1 kW amplifier |
| 4 | MONITOR connector | 9-pin D-type female connector for connection to maintenance monitor (ASCII terminal or PC with terminal emulation program) |
| 5 | EXCITER CONTROL Connector | 25-pin D-type female connector, contains the control interface that enables the RM125/RM125R to control the 1 kW amplifier |
| 6 | Exhaust Vents | Cooling air exhaust vents |
| 7 | RF OUT Connector | N-type connector for RF connection to antenna system: <ul style="list-style-type: none"> In the receive or bypass mode, serves as input for receive signals In the transmit mode, serves as output for amplified RF signals |

PS Front Panel

Figure 12 identifies the items located on the front panel of the PS unit, and Table 7 explains their functions.

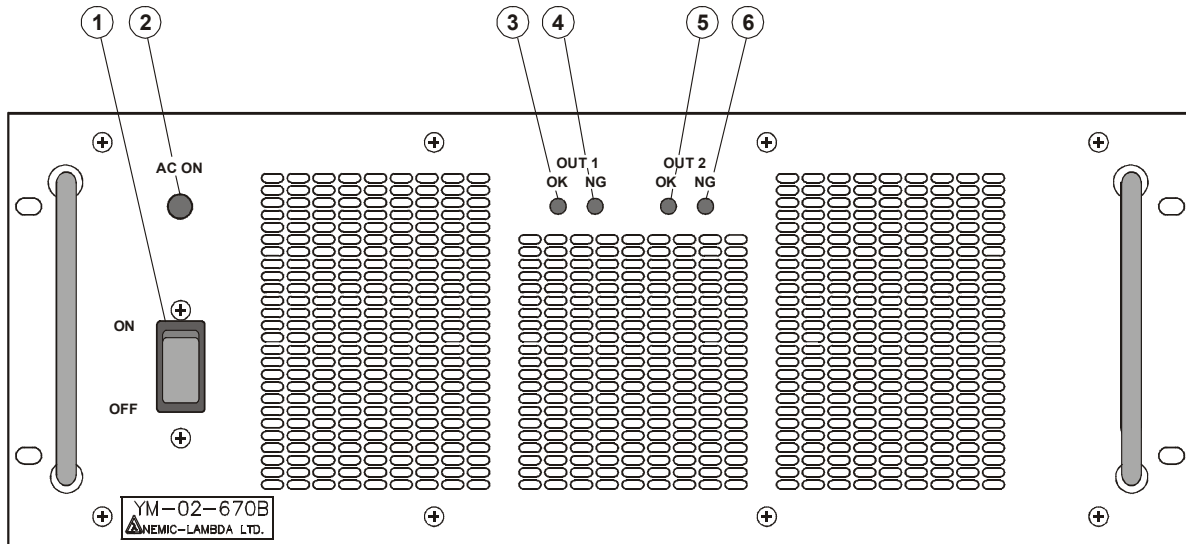

Figure 11. PS Front Panel

Table 7. PS Front Panel Items

| Item | Description | Function |
|------|--------------------|--|
| 1 | ON/OFF switch | Turns the PS on |
| 2 | AC ON indicator | Lights when the PS unit is powered |
| 3 | OUT 1 OK indicator | Lights when the power supply subsystem 1 operates normally |
| 4 | OUT 1 NG indicator | Lights when the output voltage provided by power supply subsystem 1 is not within $\pm 25\%$ of its normal value. To protect the 1 kW amplifier, the output voltage is automatically turned off in case it exceeds the maximum value. To attempt returning to normal operation, turn the PS off and then back on: if problem recurs, the PS unit must be serviced |
| 5 | OUT 2 OK indicator | Same as Item 3 for power supply subsystem 2 |
| 6 | OUT 2 NG indicator | Same as Item 4 for power supply subsystem 2 |

PS Rear Panel

Figure 12 identifies the items located on the front panel of the PS unit, and Table 8 explains their functions.

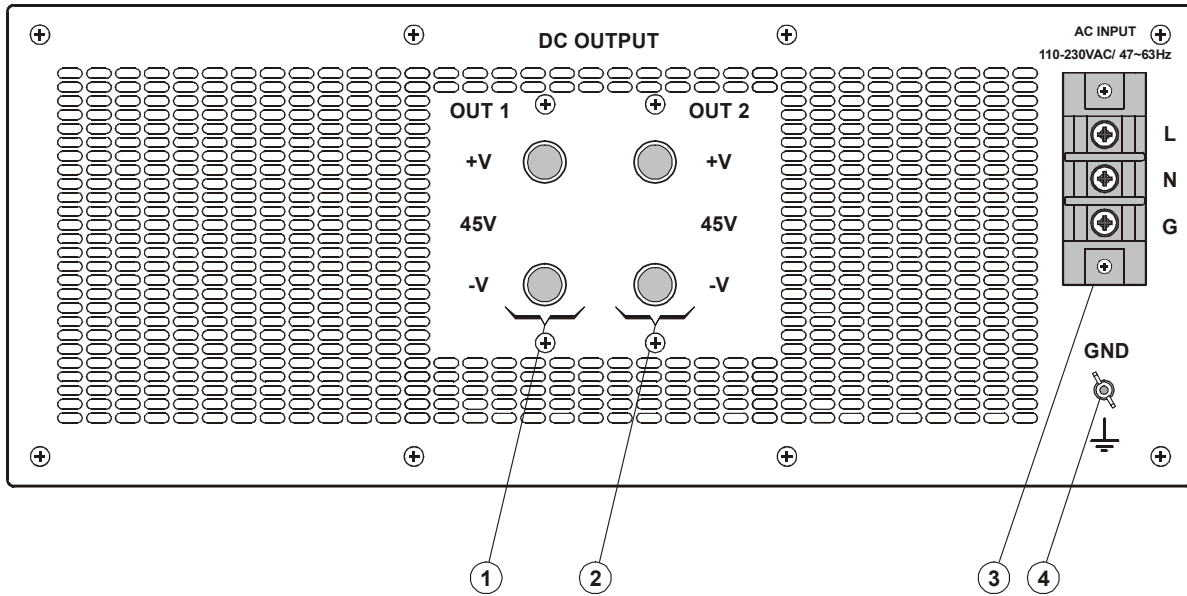

Figure 12. PS Rear Panel

Table 8. PS Rear Panel Items

| Item | Description | Function |
|------|------------------------|--|
| 1 | OUT 1 +V, -V terminals | Output voltage terminals of power supply subsystem 1 |
| 2 | OUT 2 +V, -V terminals | Output voltage terminals of power supply subsystem 2 |
| 3 | AC INPUT strip | Terminal strip, covered by a protective cover, for connection to AC power source: <ul style="list-style-type: none"> • L – line (phase) terminal • N – neutral terminal • G – ground terminal |
| 4 | Grounding screw | Connection of ground to the 1 kW amplifier |

RM1200 Equipment Installation

Safety

The safety precautions appearing below supplement the safety precautions on page 12.



Warning

High AC voltage, capable of causing death or injury on contact, is present on the AC INPUT terminal strip at the rear panel of the PS unit when the unit is connected to a power source.



Warning

Proper grounding is essential for your safety, and for good communication performance.

Do not touch the antenna and the RF connectors while the RM125/RM125R operates. During transmission, high RF voltages appear at the RF connectors, the antenna cables, and on the antenna itself. These voltages may cause severe injury or death on contact.

Make sure the antenna is not located near high-voltage lines.

All personnel must be familiar with the applicable safety requirements before attempting to install or operate the RM125/RM125R. Severe injury or death could result from failure to comply with the safety practices.



Caution

The RM1200 units are a two-person lift. Make sure that help is available during the installation activities.

Installation Planning Guidelines

This section provides the additional information necessary for planning the installation of the RM1200 option. This information supplements the information presented for the RM125/RM125R in the *Installation Planning Guidelines* section, starting on page 12.

Grounding

Failure to provide proper grounding to each system unit (RM125/RM125R, 1 kW PA and PS unit, and to the optional PPS) and to the rack in which these units are installed will degrade system operation and cause RF voltage to be present on the equipment chassis. A possible serious hazard to personnel could result, as well as equipment malfunction.

Wide copper straps, as short as possible, must be used for grounding. These straps must be clamped or bonded to a common grounding point within the rack, which is connected to a reliable, low-resistance grounding system.

Power Requirements

The RM1200 PS unit requires AC power at a nominal voltage of 110 or 220 VAC, 50/60 Hz. The PS unit will automatically select the appropriate voltage range.

The maximum AC power consumption during high-power transmission is up to 5 kW.

In addition to the circuit breaker or fuse protecting the supply line to the RM125/RM125R, a suitably

rated circuit breaker or fuse must be used to protect the supply line of the PS unit, and enable disconnection of its supply voltage during installation and maintenance.

Cooling

RM1200 units, as well as the RM125/RM125R, are cooled by internal fans. Air is taken in through the front panel vents, and discharged toward the rear. Therefore, make sure that sufficient free space is available around the equipment to enable free air flow.

Do not stack equipment units: leave at least 1U free above and below each unit installed in the rack.

Installation Data

The RM125/RM125R, the optional Pre-Selector/Post-Selector (PPS) and the RM1200 units (1 kW PA and PS) are intended for installation in one customer-provided 19" rack. The interface cable kit for MICOM RM1000 1 kW linear amplifier, option G156, is also intended for installation in the same rack.

Each equipment unit has front-mounted brackets for attachment. To provide convenient access during maintenance, each equipment unit may be installed in a sliding drawer or on slides capable of supporting the equipment weight.

The rack itself must be securely fastened to the floor, before starting the installation activities.

Sufficient front and rear clearance is required to permit convenient access to front and rear panels, as well as for removal and installation of equipment units, connection of cables, and maintenance.

Antenna and Antenna Feed System

See the requirements presented on page 13, including the use of a coaxial protector.

The high output power of the RM1200 requires particular attention to the power rating of the antenna system, and to the use of a high-quality, low-loss feed cable. Appropriate safety measures must be taken to prevent people from touching the antenna, or even getting close to it.

Preparations for Installation

Before starting the installation of a RM125/RM125R with RM1200, review the installation plan and make the following checks:

1. Identify the rack or cabinet in which the equipment will be installed, and check that the rack is securely fastened to the floor.
2. Check the mounting surfaces, and the rack mounting holes. Thoroughly clean the mounting surface and remove all paint, grease and dirt from the holes to provide a better grounding connection.
3. Check availability of AC power, and grounding arrangements.
4. Check antenna installation, in accordance with the antenna installation and operation manual.
5. Check the cable runs between the RM1200 and the prescribed antenna, including the coaxial protector. Make sure that the cables are securely fastened, and do not show signs of external damage.
6. Make sure that you have the cable set needed for the installation, which includes the RM1200 cable set, and the cables in option G156.



Caution

Before installing equipment units on slides, make sure you are familiar with the procedures needed to install slides in the rack/cabinet, and to safely install heavy equipment on the slides.

Installation Procedure

Refer to Figure 13 for a typical system interconnection diagram.

1. Identify the installation position of each equipment unit in the rack.
2. Install each equipment unit in the prescribed installation position, fastening it by means of screws to the rack rails or to the drawer front.
3. Connect grounding straps from each grounding screw (located on the rear panels of the various units), to the prescribed cabinet's grounding bar.
4. Set all the power switches on all the equipment front panels to OFF (down position).



Caution

The 1 kW PA unit does not have a power switch, and therefore it will start operating as soon as the RM125/RM125R is turned on, provided that the PS unit is already turned on.

5. Connect cables to the RM125/RM125R unit as explained in the *Installation Procedure – Basic Radio* section, starting on page 14, including the relevant DC power connections. The only difference is that the RM125/RM125R RF OUT connector must be connected to the RF IN connector of the 1 kW amplifier.

If your installation includes the PPS, use the procedure explained in the *Installation Procedure – Radio with PPS Option* section, starting on page 16.
6. Connect the control cable between the RM125/RM125R AMP-CONT connector and the 1 kW amplifier EXCITER CONTROL connector.
7. Connect the antenna feed cable to the RF OUT connector of the 1 kW amplifier.
8. Connect the DC power cable between the 1 kW amplifier +48VDC connector and the four DC OUTPUT terminals of the PS unit. Pay attention to correct connection of the two pairs of leads to the DC OUTPUT terminals, with respect to polarity and OUT pair.
9. Connect the three leads of the PS unit AC power cable to the AC INPUT terminal strip, in accordance with the functions of each lead. After making the connections, make sure that the protective cover of the terminal strip is properly installed.
10. Connect the other end of the AC power cable of the PS unit to the prescribed outlet on the power distribution box of the cabinet.

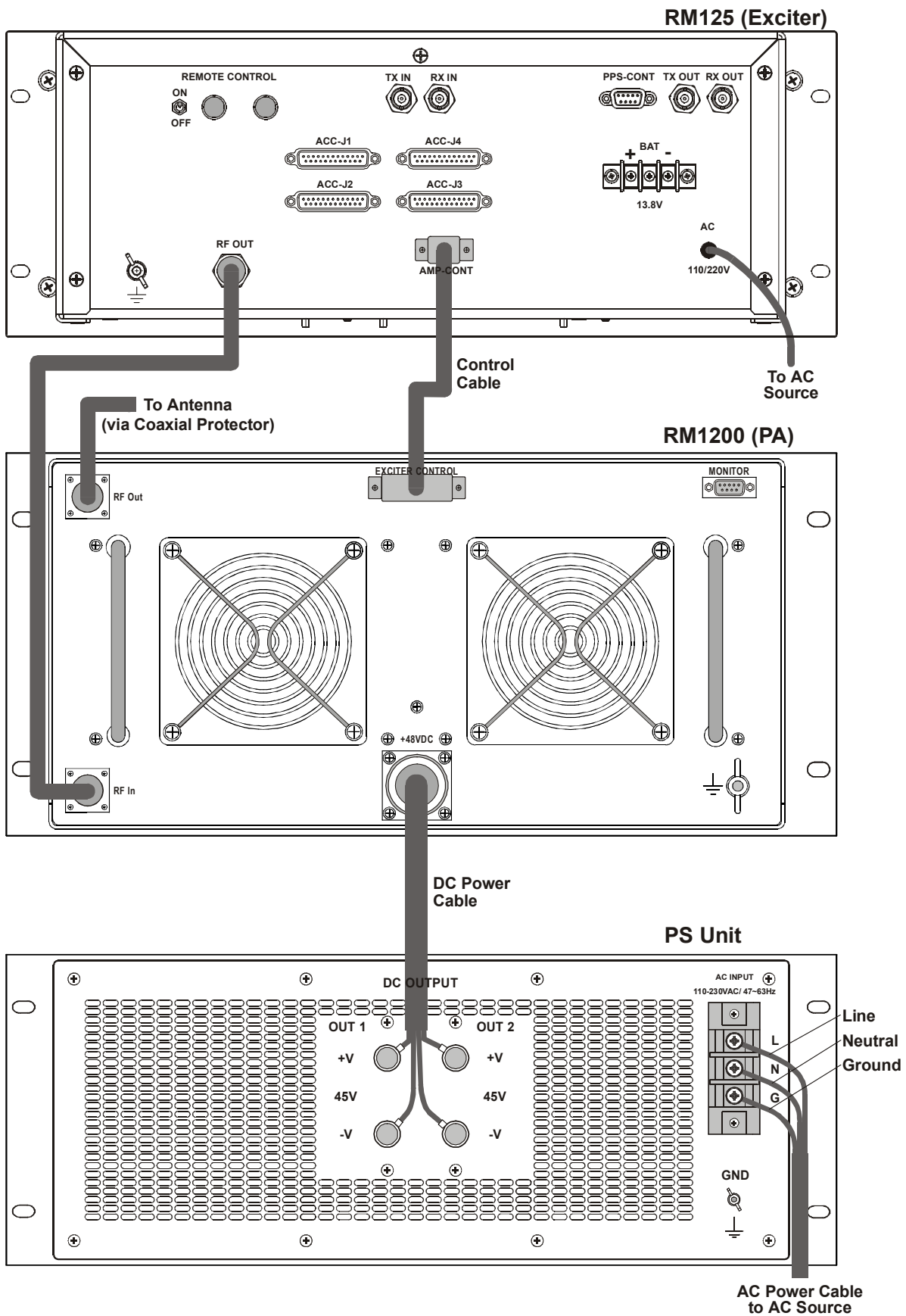

Figure 13. Typical RM1200 System Connections

RM1200 Operation

General

The following instructions present operating procedures specific to the RM1200 option for the RM125 and RM125R. It is assumed that the operator is familiar with the common MICOM-3 operating procedures, as described in the “Owner’s Guide, MICOM-3E/3T/3R HF-SSB Transceivers”, Publication 6886867J01, and the applicable MICOM-3 Supplements that cover optional features.

Preparations for Operation

1. Set the REMOTE CONTROL switch on the rear panel of the RM125/RM125R to the OFF (down) position.
2. For the RM125R, set the internal speaker switch to ON (up).

Equipment Turn-On

1. Apply power to the RM125/RM125R by setting its AC power switch to ON (up).
2. Set the AC power switch on the PS unit to ON, and monitor its indications. The expected indications, as well as what to do if a problem is detected, are described in Table 9.
3. Turn the RM125/RM125R ON/OFF switch and volume control clockwise and adjust for a comfortable listening level.
4. The 1 kW amplifier is also turned on. Monitor its power-up indications. The expected indications, as well as what to do if a problem is detected, are described in Table 9.
5. If necessary, select the prescribed channel and operating mode of the RM125/RM125R. Make sure that the RM125/RM125R is programmed to use the 1 kW amplifier (you should see **AMP** on the **PROG>RAD>OPTS>ACC** menu).

Table 9. RM1200 Power-up Indications

| Unit | Expected Indication | What to do if not ... |
|---------|--|--|
| PS Unit | AC ON indicator lights | Check that AC power is available, and that the PS unit is properly connected to the AC distribution panel |
| | OUT 1 and OUT 2 indicators light. NG 1 and NG2 indicators off | The PS unit requires service. Turn the PS unit off: do not attempt to continue using the 1 kW amplifier until the problem is corrected. You can still transmit and receive using the RM125/RM125R (maximum transmit power – 125W) by selecting NONE on the PROG>RAD>OPTS>ACC menu. |

Table 9. RM1200 Power-up Indications (Cont.)

| Unit | Expected Indication | What to do if not ... |
|---------|---|--|
| 1 kW PA | <p>All the front panel indicators flash together a few times as the unit performs its power-up initialization sequence, and then turn off</p> <p>The 1 kW amplifier tunes to the RM125/RM125R operating frequency. After successful tuning, its front panel LCD displays the selected frequency</p> | <p>If the FAULT indicator lights, a fault has been detected in the 1 kW amplifier (you may read the problem by means of its front panel LCD). Service the 1 kW amplifier. However, you can still transmit and receive using the RM125/RM125R by selecting NONE on the PROG>RAD>OPTS>ACC menu.</p> <p>If the BYPASS indicator lights, make sure to select AMP on the RM125/RM125R PROG>RAD>OPTS>ACC menu</p> <p>Check for proper connection of the RF and control cables between the RM125/RM125R (or other exciter unit you are using), and the 1 kW amplifier.</p> <p>If tuning fails even after turning the equipment off and on again in the proper turn-on sequence described above:</p> <ul style="list-style-type: none"> • You are still able to transmit and receive using the RM125/RM125R by permanently bypassing the 1 kW amplifier. For the RM125/RM125R, you bypass the 1 kW amplifier by selecting NONE on the PROG>RAD>OPTS>ACC menu. • In an emergency, you may continue using the 1 kW amplifier as long as no protection circuit is activated, because a tuning failure degrades performance only slightly (the 1 kW amplifier uses the highest harmonic filter sub-band, resulting in somewhat higher harmonics levels when using lower sub-bands). However, you must have the equipment serviced on the first opportunity. |

Operating Instructions

You are now ready to start using the radio set. For operating procedures, you may use the information appearing in the “Owner’s Guide, MICOM-3E/3T/3R HF-SSB Transceivers”, Publication 6886867J01.

1. During reception, you will see the receive indications (**Rx** and the operating frequency) on the 1 kW amplifier LCD.

Note *The tune indications described in Table 9 will appear whenever you change the operating frequency, and also whenever the ENT key of the RM125/RM125R is pressed.*

2. When you press the PTT to start a transmission, the TX indicator of the 1 kW amplifier lights, and you will see the transmit indications (**Tx** and the operating frequency) on its LCD.

The second row of the LCD displays the transmit power, and the VSWR.

Note *During normal transmission, the TX indicator lights, and the BYPASS and FAULT indicators are off.*

If the BYPASS and FAULT indicators light, the 1 kW amplifier switched to the bypass mode because it either overheated to dangerous levels, or the antenna VSWR is too high. You can read the information displayed by the LCD to get additional details (see Table 4). In this case:

1. *Check that the amplifier cooling fans operate normally, and that nothing blocks the air intake and exhaust vents.*
2. *Check the antenna system and the feed cable for accidental disconnection or damage.*
3. *If problem persists after turning the equipment off and then on again in the proper sequence, service is needed.*

If the FAULT indicator flashes but the BYPASS indicator is off, the 1 kW amplifier halved its transmit power because it overheated. In this case, take the steps described in Item 1 above.

Equipment Turn-Off

1. Turn the RM125/RM125R off: turn the front panel ON/OFF switch and volume control fully counterclockwise, beyond the detent position. Now set its AC power switch to OFF.

Note *At this stage, the 1 kW amplifier is also turned off.*

2. Turn the PS unit off by setting its ON/OFF switch to OFF.